

AM-980

Electric Actuator for 9800, 980F, 9880 and 988F Valves Series



Via Circonvallazione, 10
13018 Valduggia (VC), Italy
Tel: +39 0163 47891
Fax: +39 0163 47895
www.vironline.com



Electric actuator with ISO 5211 connection
Fast bayonet connection with ring for F04-□9mm,
Travel 90°, in 30 to 120 seconds
Manual override
With 120cm electric wire
Enclosure protection IP54 according EN 60529
CE compliant

Available on following versions:

- 2/3 points control, 230VAC
- 2/3 points control, 24VAC
- 0-10V control signal, 24V AC/DC

Ver. 0-10V with equal-percentage, linear or quadratic characteristic

Working ambient temperature: -10° to +55°C (RH 5%-95%, no condensation)



TECHNICAL DATA

VIR code	P. Supply	Control	Power	Travel time
KAM15F120.800	230VAC	2/3 points	2,0W	120 sec.
KAM15F122.800	24VAC	2/3 points	1,6W	120 sec.
KAM15S132.800	24V AC/DC	0-10V	4,9W	30/60/120sec. ¹

¹Can be set with microswitches

DIMENSIONS

Dimension in mm, weight 0,7kg

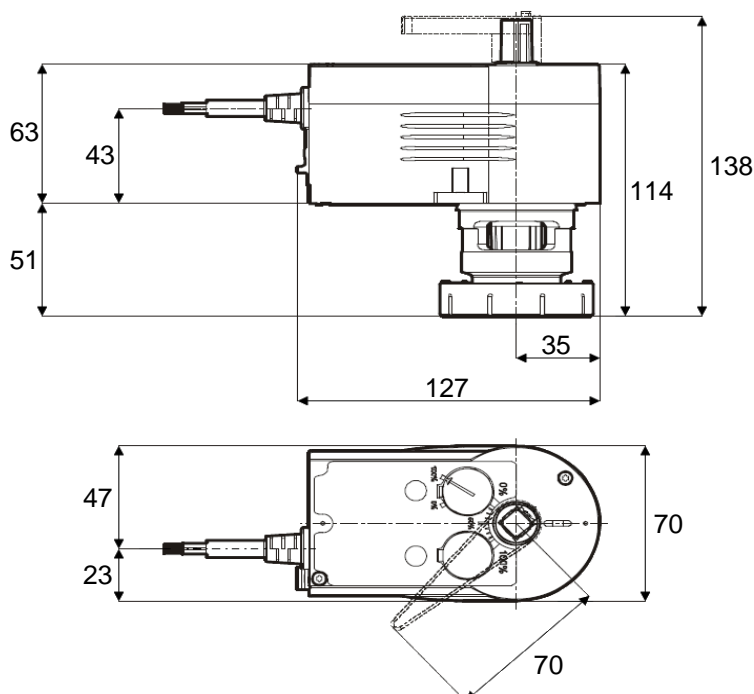

WIRING DIAGRAMS

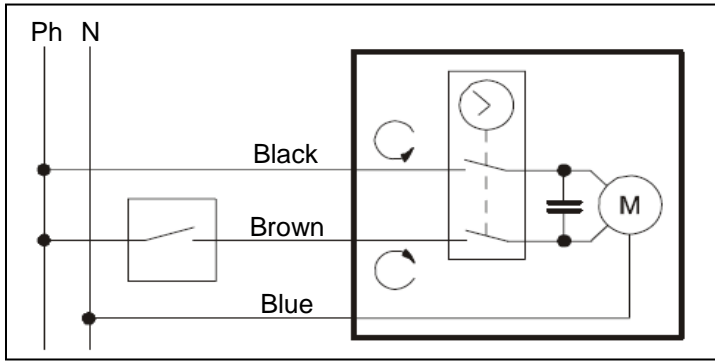

KAM15F120.800, KAM15F122.800, 2 points control

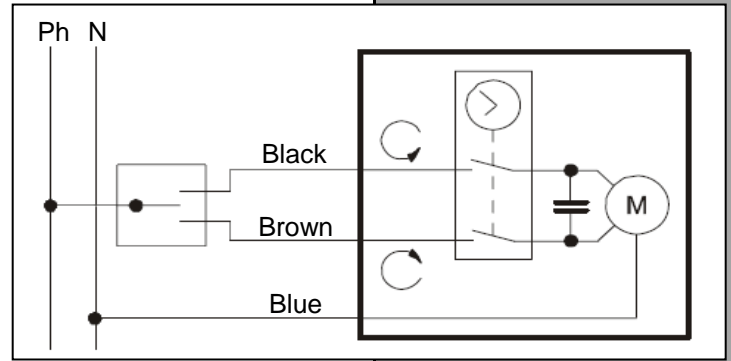

KAM15F120.800, KAM15F122.800, 3 points control

Ref.	Designation
N	Wiring to neutral
Ph	Wiring to phase
+	Wiring to + pole
-	Wiring to - pole

Alternatively connect black or brown contact, isolate unused wire (or connect to switch). Alternatives have as a result inverse rotation in relation to control signal.

Actuator can be used with 2 or 3 points control by using above wiring diagrams and isolating separately red and gray wires (**do not connect them with each other**).

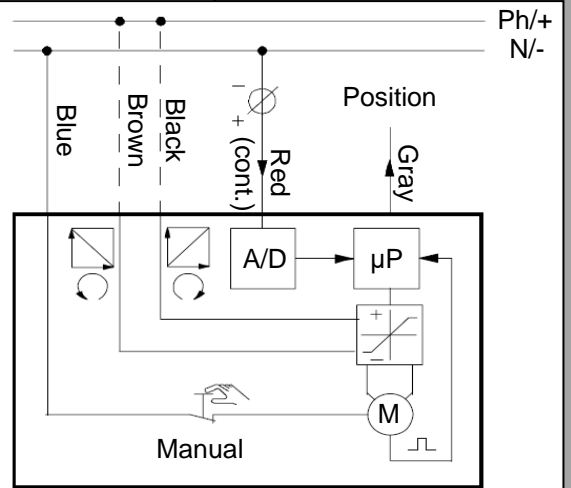

KAM15S132.800, 0-10V control signal

CONTROL OPTIONS

Microswitches settings (KAM15S132.800 only), characteristic resulting on main line if used together with VIR 9800 valves series (not applicable to 980F series)

	120 sec. equal-percentage characteristic ¹		120 sec. quadratic characteristic		120 sec. linear characteristic
	60 sec. equal-percentage characteristic		60 sec. quadratic characteristic		60 sec. linear characteristic
	35 sec. equal-percentage characteristic				35 sec. linear characteristic

¹Factory setting

— phase wired on black
 - - - phase wired on brown

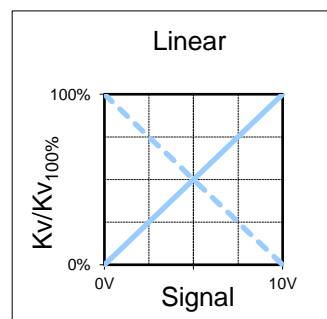
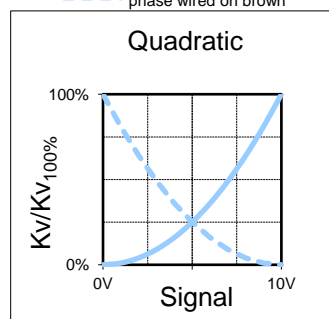
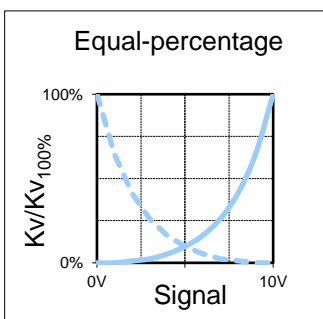

Via Circonvallazione, 10
 13018 Valduggia (VC), Italy
 Tel: +39 0163 47891
 Fax: +39 0163 47895
 www.vironline.com