

9610

Direct-Acting Brass Pressure Reducing Valve



Via Circonvallazione, 10
13018 Valduggia (VC), Italy
Tel: +39 0163 47891
Fax: +39 0163 47895
www.vironline.com



Direct-acting brass pressure reducing valve
Threaded F/F (ISO 228/1)
Testing according to DIN EN1567
Max pressure reduction ratio 10:1
Downstream setting pressure range from 0,5bar to 6bar
(from 1,5bar to 6,0bar for DN \geq 32)
Piston type, pressure compensation system
With threaded F (1/4" ISO 228/1) pressure gauge connection

PN25 (PN16 when used with air)
Free of CE marking (cat. according to Art. 4.3 Dir. 2014/68/EU)

Working conditions:

- Suitable for: water, 0°C to +80°C
- Suitable for: air, 0°C to +80°C
- Not suitable for: gases and liquids group 1 (Dir. 2014/68/EU)



PARTLIST

N.	Part	Material	Norm
1	Lower cap	Brass	EN12165 CW617N
2	Gasket	Fasit	-
3	Shutter	Brass ¹	EN12164 CW617N
4	O-ring	NBR	-
5	Seat	Stainless steel	AISI 303
6	Body	Brass	EN12165 CW617N
7	Side cap	Acetal resin	-
8	Diaphragm	Brass	EN12164 CW617N
9	Diaphragm O-ring	NBR	-
10	Upper cap	Brass	EN12165 CW617N
11	Spring	Cadmium pl. steel	-
12	Ring	Acetal resin	-
13	Spring press top	Brass	EN12165 CW617N

¹Stainless steel AISI 303 for DN \geq 32

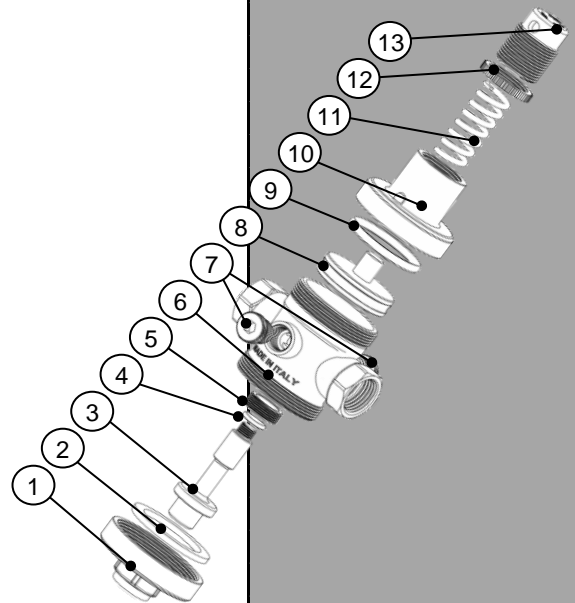

DIMENSIONS

DN	G	HA [mm]	HB [mm]	L [mm]	Flow rng ¹ [m ³ /h]	Weight [g]
015	1/2"	43	77	75	0,5-3,0	790
020	3/4"	43	77	76	1,0-4,8	860
025	1"	61	99	91	2,0-6,0	1340
032	1 1/4"	70	150	116	4,0-8,0	2090
040	1 1/2"	70	150	125	4,5-8,5	2180
050	2"	83	167	140	7,5-10	3100
065	2 1/2"	90	170	148	8,5-11	4100
080	3"	102	183	177	10-13,2	5520
100	4"	110	200	190	12-15,6	6970

¹Suggested flow range, max flow range is about double the indicated value

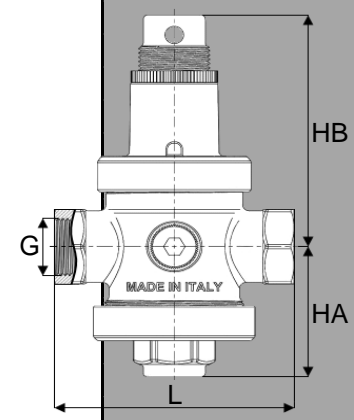

230208

VALVE SIZING

The first step for choosing the proper Fig. 9610 pressure reducing valve for an application is to calculate the design flow (the expected maximum total flow required by the plumbing system). The national laws in-force should be taken as reference to calculate such flow.

By using the below graph (by drawing an upward line corresponding to the design flow) it's then possible to select a proper diameter by following the directions given by the dashed lines.

In the given example, with a design flow of 2m³/h a DN25 or larger should be used for domestic applications. A DN15 pressure reducing valve should be used only for industrial applications.

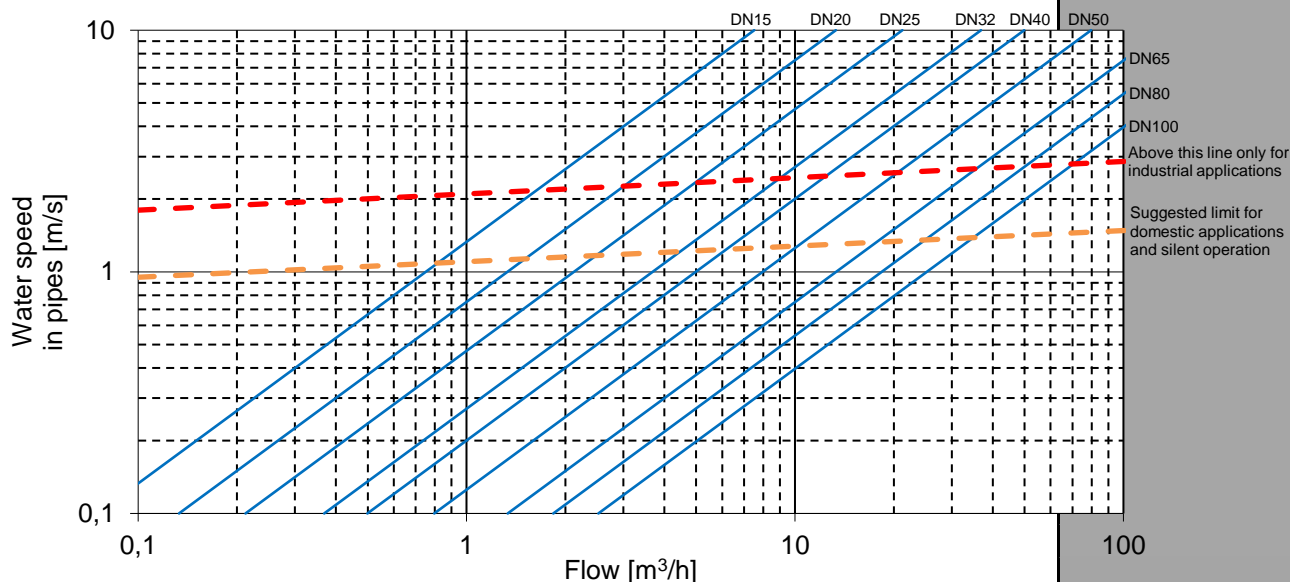
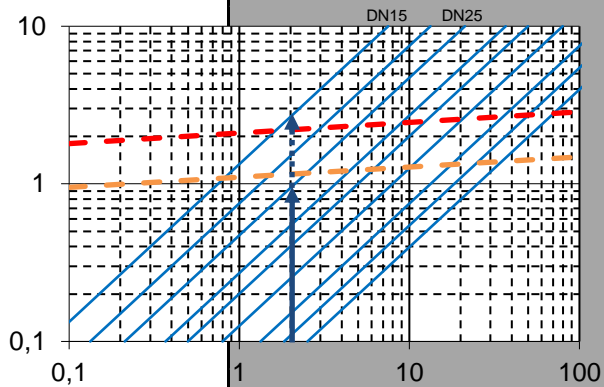

The Fig. 9610 pressure reducing valves have a Max pressure reduction ratio of 10:1, meaning they can reduce the inlet pressure up to 10 times without generating cavitation.

Cavitation is responsible for a quick wear out of the internal components of the pressure reducer and must therefore be avoided.

Two pressure reducers mounted serially can however be used for applications requiring an outlet pressure of less than one tenth of the inlet pressure.

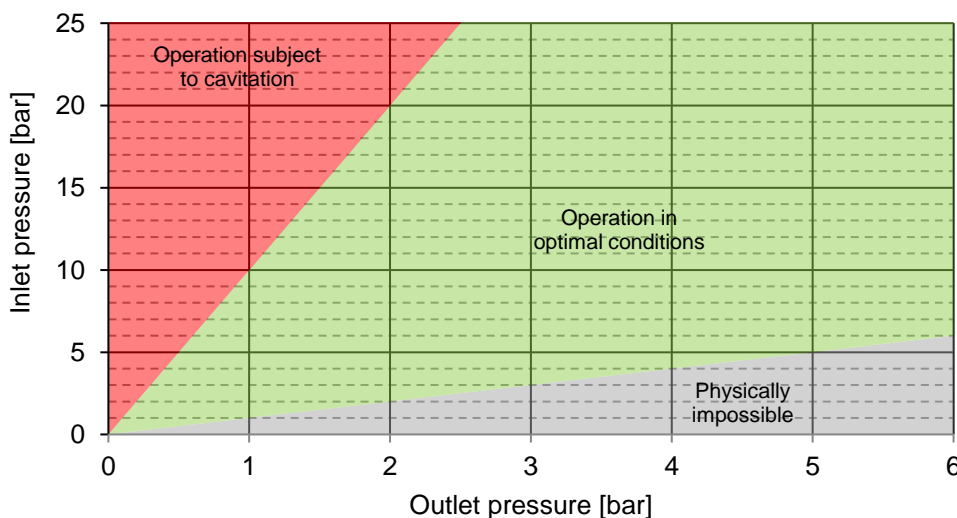

Via Circonvallazione, 10
13018 Valduggia (VC), Italy
Tel: +39 0163 47891
Fax: +39 0163 47895
www.vironline.com

PRESETTING

Fig. 9610 pressure reducing valves are factory preset at an outlet pressure of 3bar. Such pressure can be modified by acting on the spring press top, providing the system is shut of:

- a) loosen the ring;
- b) turn the spring press top with a tool (for example a screwdriver) clockwise to increase the preset value or counterclockwise to decrease it; if a (optional) manometer is installed on the dedicated side connection, it will be possible to read the preset outlet pressure value on it;
- c) tighten back the ring.

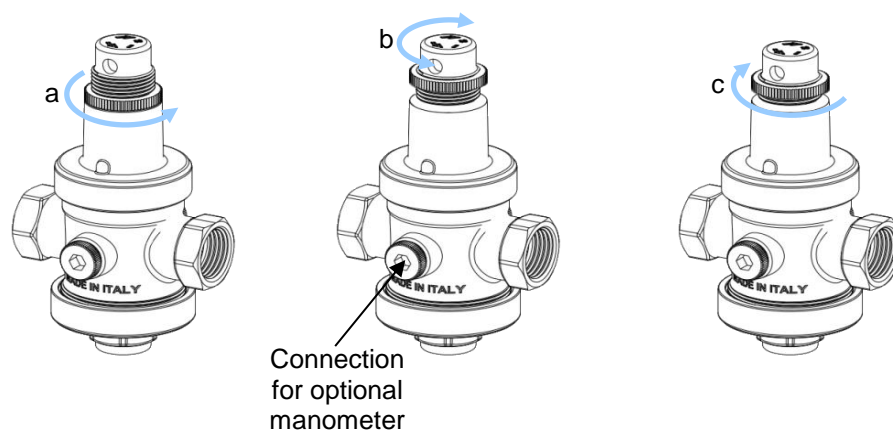

The pressure set with above procedure will be kept while the system is shut-off. Water flowing through the pressure reducer generates a headloss that will be deducted by the preset value.

This pressure drop, depending on the flow passing through the pressure reducer, can be estimated with below graph.

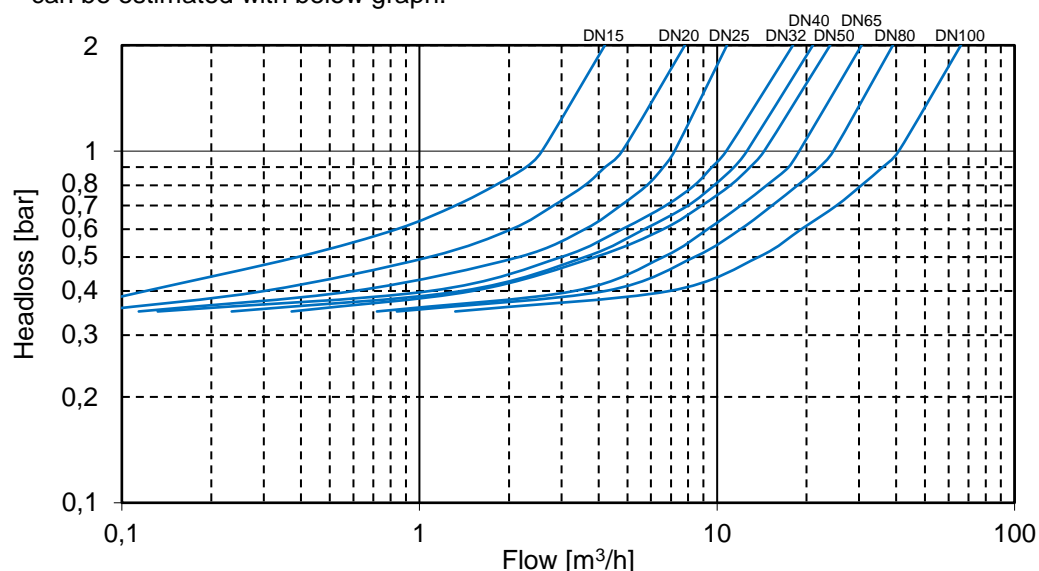

Via Circonvallazione, 10
13018 Valduggia (VC), Italy
Tel: +39 0163 47891
Fax: +39 0163 47895
www.vironline.com

INSTALLATION

Install the pressure reducer so that the flow direction matches the direction of the arrow indicated on the body of the valve. Our pressure reducers can be installed in any horizontal or vertical position.

The pressure reducer can be damaged by impurities; to protect, not only the valve, but also all the devices installed in the plumbing system (thermostatic mixers, taps, showers and so on) a strainer should be installed at the inlet of the pressure reducer.

Pressure at the outlet of the pressure reducer may increase when devices used to produce/store hot water (or pipes subject to thermal changes) are installed on the outlet of the valve. This is not caused by the pressure reducer itself but by the increase in the water volume due to temperature changes. To eliminate this problem, an expansion vessel should be installed at the outlet of the pressure reducer in-between the valve and these devices.

Finally a water hammer arrestor should be installed to avoid damages to the inner components of the pressure reducer due to violent backpressures.

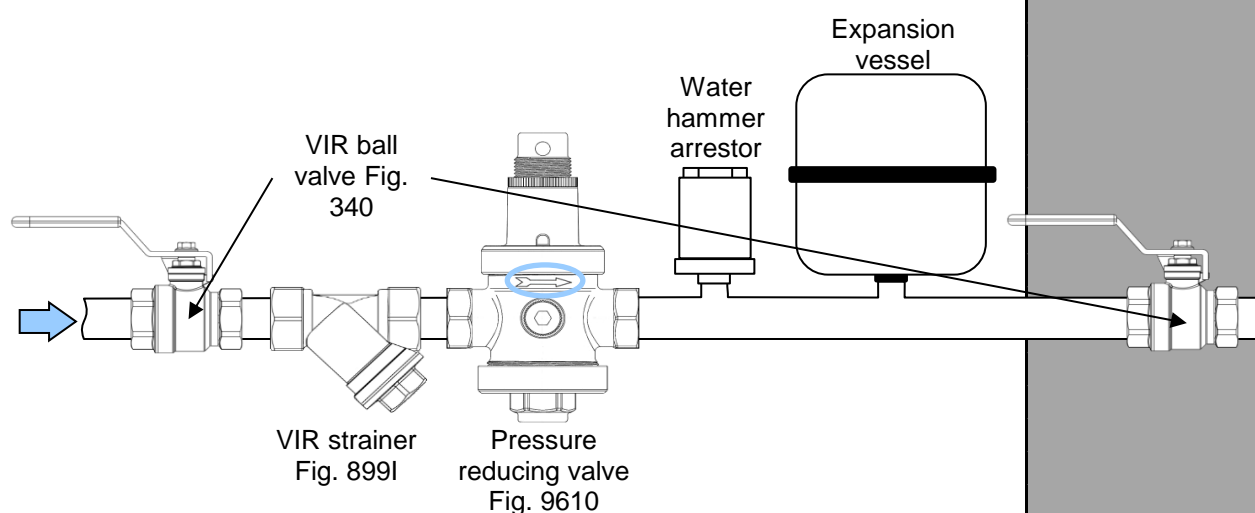

Via Circonvallazione, 10
13018 Valduggia (VC), Italy
Tel: +39 0163 47891
Fax: +39 0163 47895
www.vironline.com